

ON-LINE / LIVE STORAGE SHELVING SYSTEMS

2020
2021

Extract from general catalog

[ssi-schaefer.com](https://www.ssi-schaefer.com)

Chapter G



SSI SCHÄFER

On-line shelving/ live storage racks

PDF

Reducing costs by optimizing processes is the objective in every area of industry. SSI SCHAEFER offers an entire range of optimized systems for providing small items in assembly areas or on the assembly line.

These systems utilize the first-in-first-out principle (FiFo) and can be equipped with shelves or roller bars, guaranteeing problem-free assembly processes.

The diversity of the SSI SCHAEFER dynamic systems ensures that the optimum dynamic storage concept can be found for every load carrier. SSI SCHAEFER systems and solutions cover applications ranging from light loads to moderate loads and also heavy loads.

The diverse range of containers made of plastic and steel from SSI SCHAEFER ensure space-saving storage and the ideal storage of the materials.

i Information regarding **inspection requirements**
for **rack systems**

Chapter J, page J1

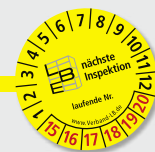



R 3000 on-line shelving

page G2



R 7000 on-line shelving

page G6

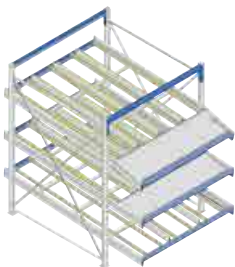

KDR live storage shelving

page G12

The meaning of the pictograms:



Bay load*

* All specified load values apply for uniformly distributed loads.

Boxes / containers

Modular shelving

Longspan racking

Pallet racking

Cantilever racking

Mezzanines / platforms

On-line shelving / KDR shelving

Semi-automated solutions

Logistics systems

Appendix

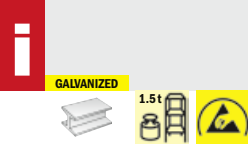

R 3000 on-line shelving with shelves

On-line shelving provides a reliable means of storage for any type of box with diverse dimensions, making them a universal solution.

The high load capacity of 1.5 t per bay, its flexibility through the combination of basic and expansion bays to create shelving rows, along with the cost-effective construction with consistently galvanized components from the R 3000 system distinguishes this on-line shelving from SSI SCHAEFER.

The lane guides made of wire bows can be inserted with a 41 mm spacing pattern to partition the shelving.

Pre-assembled frames and system components that can be assembled without screws enable these shelves to be set up rapidly.

On the inclined levels, a stop beam or a stop strip secures the containers. The side rails prevent goods from falling between the frames.

- ▶ **Plug-in design for rapid assembly**
- ▶ **Pre-assembled upright frame**
consisting of frames, compartment stays and foot plates
- ▶ **Upright profile**
with 53 mm lug pitch
- ▶ **Height-adjustable shelves**
- ▶ **High loading capacity**
of up to 1,500 kg per bay
- ▶ **Floor fixing not required**
provided that the height/depth ratio does not exceed 4 : 1
- ▶ **Inclined shelves**
ensure gravity-forced box supply and provide a clear view while improving handling on the removal side
- ▶ **System components made of galvanized sheet steel**
- ▶ **Suitable for use in ESD areas**
to protect high-quality electronic components
- ▶ **Bay width/system dimensions and installation situation**

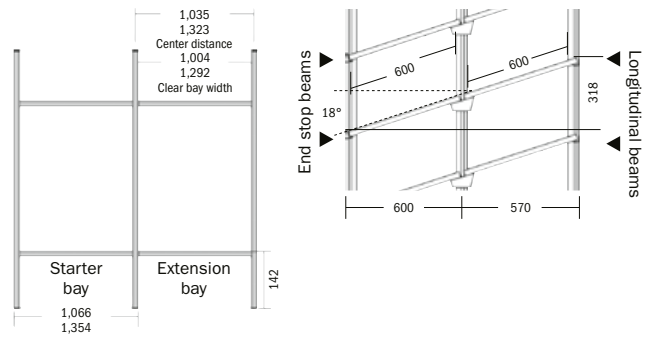

End stop beam, front

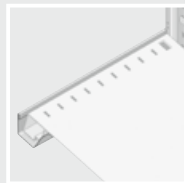

Longitudinal beam, rear

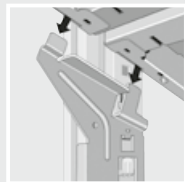

Intermediate shelf bracket



Lane guides made of wire bows

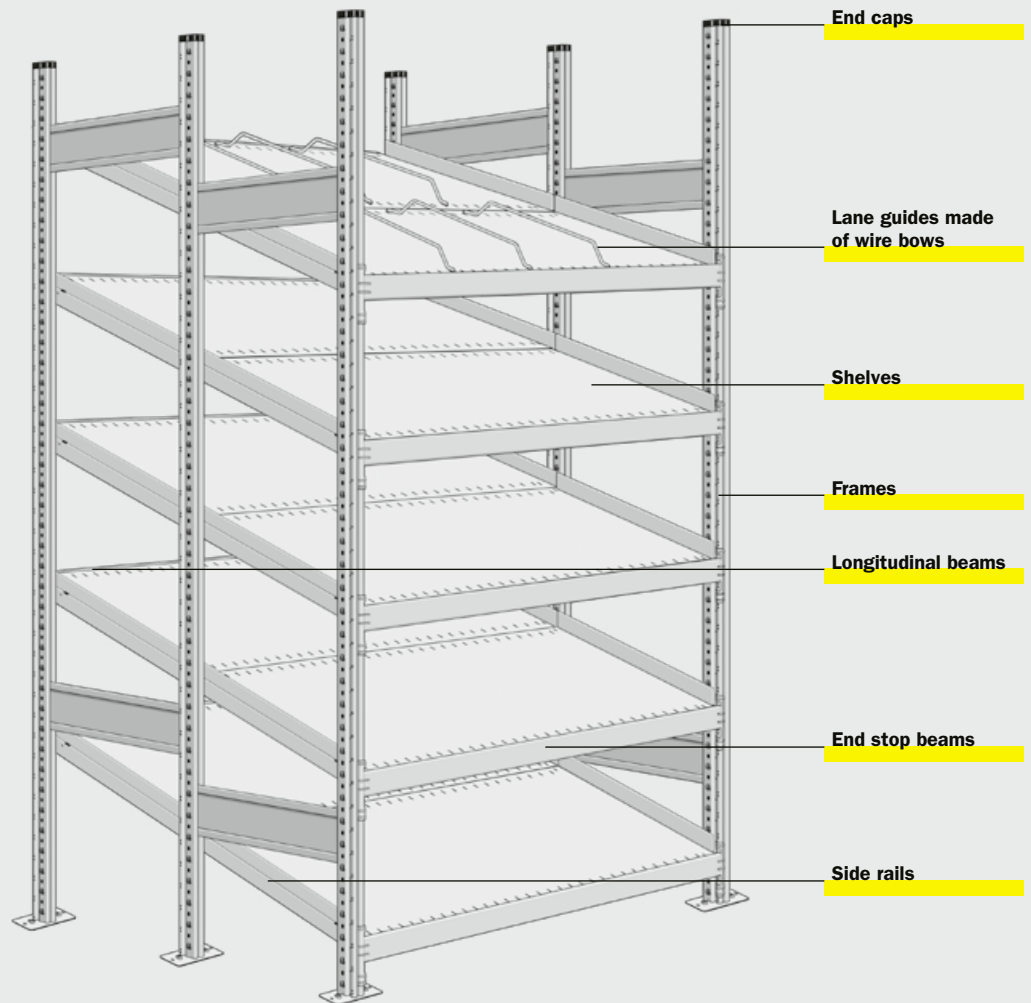

MBR 3000 single-row shelving with tilted shelves



Offer without containers

MBR 3000 complete shelving system with 3 tilted shelves (starter bays) – rack height 1,536 mm

2 pre-assembled upright frames, 3 shelves, 3 longitudinal and 3 end stop beams, 6 side rails, 4 end caps.

Item	Usable depth (mm)	Clear bay width (mm)	Max. load per shelf (kg)	Order no.
MBR-341015-GF-S-3	400	1,004	100	331000
MBR-341315-GF-S-3		1,292	150	331010
MBR-351015-GF-S-3	500	1,004	100	331020
MBR-351315-GF-S-3		1,292	150	331030
MBR-361015-GF-S-3	600	1,004	100	331040
MBR-361315-GF-S-3		1,292	150	331050
MBR-381015-GF-S-3	800	1,004	200	331060
MBR-381315-GF-S-3		1,292	250	331070

Extension bays

1 pre-assembled upright frame, 3 shelves, 3 longitudinal and 3 end stop beams, 2 end caps.

Item	Usable depth (mm)	Clear bay width (mm)	Max. load per shelf (kg)	Order no.
MBR-341015-AF-S-3	400	1,004	100	331100
MBR-341315-AF-S-3		1,292	150	331110
MBR-351015-AF-S-3	500	1,004	100	331120
MBR-351315-AF-S-3		1,292	150	331130
MBR-361015-AF-S-3	600	1,004	100	331140
MBR-361315-AF-S-3		1,292	150	331150
MBR-381015-AF-S-3	800	1,004	200	331160
MBR-381315-AF-S-3		1,292	250	331170

Additional compartment levels

1 shelf, 1 longitudinal and 1 end stop beam.

Item	Usable depth (mm)	Clear bay width (mm)	Max. load per shelf (kg)	Order no.
MBR-341004-ZF-SE	400	1,004	100	331400
MBR-341292-ZF-SE		1,292	150	331410
MBR-351004-ZF-SE	500	1,004	100	331420
MBR-351292-ZF-SE		1,292	150	331430
MBR-361004-ZF-SE	600	1,004	100	331440
MBR-361292-ZF-SE		1,292	150	331450
MBR-381004-ZF-SE	800	1,004	200	331460
MBR-381292-ZF-SE		1,292	250	331470

Order no. = on stock



Offer without containers

MBR 3000 complete shelving system with 5 tilted shelves (starter bays) – rack height 2,278 mm

2 pre-assembled upright frames, 5 shelves, 5 longitudinal and 5 end stop beams, 10 side rails, 4 end caps.

Item	Usable depth (mm)	Clear bay width (mm)	Max. load per shelf (kg)	Order no.
MBR-341022-GF-S-5	400	1,004	100	331200
MBR-341322-GF-S-5		1,292	150	331210
MBR-351022-GF-S-5	500	1,004	100	331220
MBR-351322-GF-S-5		1,292	150	331230
MBR-361022-GF-S-5	600	1,004	100	331240
MBR-361322-GF-S-5		1,292	150	331250
MBR-381022-GF-S-5	800	1,004	200	331260
MBR-381322-GF-S-5		1,292	250	331270

Extension bays

1 pre-assembled upright frame, 5 shelves, 5 longitudinal and 5 end stop beams, 2 end caps.

Item	Usable depth (mm)	Clear bay width (mm)	Max. load per shelf (kg)	Order no.
MBR-341022-AF-S-5	400	1,004	100	331300
MBR-341322-AF-S-5		1,292	150	331310
MBR-351022-AF-S-5	500	1,004	100	331320
MBR-351322-AF-S-5		1,292	150	331330
MBR-361022-AF-S-5	600	1,004	100	331340
MBR-361322-AF-S-5		1,292	150	331350
MBR-381022-AF-S-5	800	1,004	200	331360
MBR-381322-AF-S-5		1,292	250	331370

Additional compartment levels

1 shelf, 1 longitudinal and 1 end stop beam.

Item	Usable depth (mm)	Clear bay width (mm)	Max. load per shelf (kg)	Order no.
MBR-341004-ZF-SE	400	1,004	100	331400
MBR-341292-ZF-SE		1,292	150	331410
MBR-351004-ZF-SE	500	1,004	100	331420
MBR-351292-ZF-SE		1,292	150	331430
MBR-361004-ZF-SE	600	1,004	100	331440
MBR-361292-ZF-SE		1,292	150	331450
MBR-381004-ZF-SE	800	1,004	200	331460
MBR-381292-ZF-SE		1,292	250	331470

Boxes / containers

Modular shelving

Longspan racking

Pallet racking

Cantilever racking

Mezzanines / platforms

On-line shelving / KDR shelving

Semi-automated solutions

Logistics systems

Appendix

MBR 3000 double-row shelving with tilted shelf levels



MBR 3000 complete shelving system with 3 tilted shelves (starter bays) – rack height 1,536 mm

2 pre-assembled upright frames, 6 shelves, 3 longitudinal and 3 end stop beams, 6 intermediate shelf brackets, 12 side rails, 6 end caps.

Item	Usable depth (mm)	Clear bay width (mm)	Max. load per shelf (kg)	Order no.
MBR-351015-GF-DS-3	1,000	1,004	100	331520
MBR-351315-GF-DS-3		1,292	150	331530
MBR-361015-GF-DS-3	1,200	1,004	100	331540
MBR-361315-GF-DS-3		1,292	150	331550

Extension bays

1 pre-assembled upright frame, 6 shelves, 3 longitudinal and 3 end stop beams, 6 intermediate shelf brackets, 2 end caps.

Item	Usable depth (mm)	Clear bay width (mm)	Max. load per shelf (kg)	Order no.
MBR-351015-AF-DS-3	1,000	1,004	100	331620
MBR-351315-AF-DS-3		1,292	150	331630
MBR-361015-AF-DS-3	1,200	1,004	100	331640
MBR-361315-AF-DS-3		1,292	150	331650

Additional compartment levels

1 shelf, 1 longitudinal and 1 end stop beam, 2 intermediate shelf brackets.

Item	Usable depth (mm)	Clear bay width (mm)	Max. load per shelf (kg)	Order no.
MBR-351004-ZF-SD	1,000	1,004	100	331920
MBR-351292-ZF-SD		1,292	150	331930
MBR-361004-ZF-SD	1,200	1,004	100	331940
MBR-361292-ZF-SD		1,292	150	331950



MBR 3000 complete shelving system with 5 tilted shelves (starter bays) – rack height 2,278 mm

2 pre-assembled upright frames, 10 shelves, 5 longitudinal and 5 end stop beams, 10 intermediate shelf brackets, 20 side rails, 6 end caps.

Item	Usable depth (mm)	Clear bay width (mm)	Max. load per shelf (kg)	Order no.
MBR-351022-GF-DS-5	1,000	1,004	100	331720
MBR-351322-GF-DS-5		1,292	150	331730
MBR-361022-GF-DS-5	1,200	1,004	100	331740
MBR-361322-GF-DS-5		1,292	150	331750

Extension bays

1 pre-assembled upright frame, 10 shelves, 5 longitudinal and 5 end stop beams, 10 intermediate shelf brackets, 2 end caps.

Item	Usable depth (mm)	Clear bay width (mm)	Max. load per shelf (kg)	Order no.
MBR-351022-AF-DS-5	1,000	1,004	100	331820
MBR-351322-AF-DS-5		1,292	150	331830
MBR-361022-AF-DS-5	1,200	1,004	100	331840
MBR-361322-AF-DS-5		1,292	150	331850

Additional compartment levels

1 shelf, 1 longitudinal and 1 end stop beam, 2 intermediate shelf brackets.

Item	Usable depth (mm)	Clear bay width (mm)	Max. load per shelf (kg)	Order no.
MBR-351004-ZF-SD	1,000	1,004	100	331920
MBR-351292-ZF-SD		1,292	150	331930
MBR-361004-ZF-SD	1,200	1,004	100	331940
MBR-361292-ZF-SD		1,292	150	331950

Order no. = on stock

Individual components



i Additional information about the R 3000 on-line shelving
on request

Individual components and accessories for the “MBR” on-line shelving

Item	Usable depth (mm)	Height/Length (mm)	Load (max. kg/bay)	Order no.	Item	Usable depth (mm)	Height/Length (mm)	Load (max. kg)	Order no.
Basic shelving frame					Longitudinal beams				
RR34315-V-M	400	1,536	2,500	6671800	LTR 31004	—	1,004	250	330340
RR35315-V-M	500	1,536	2,500	6671801	LTR 31292	—	1,292	250	330350
RR36315-V-M	600	1,536	2,500	6671802					
RR38315-V-M	800	1,536	2,500	6671803					
Shelving extension frame – double-row					End stop beams				
RRA35315-V-M-Z	470	1,536	2,500*	6671990	ATR 31004	—	1,004	250	330310
RRA36315-V-M-Z	570	1,536	2,500*	6671991	ATR 31292	—	1,292	250	330320
Basic shelving frame					End stop rails				
RR34322-V-M	400	2,278	2,500	6671816	ASL 3100	—	994	—	330610
RR35322-V-M	500	2,278	2,500	6671817	ASL 3130	—	1,282	—	330620
RR36322-V-M	600	2,278	2,500	6671818					
RR38322-V-M	800	2,278	2,500	6671819					
Shelving extension frame – double-row					Side rails				
RRA35322-V-M-Z	470	2,278	2,500*	6671993	SF 3404 V	400	40	—	330880
RRA36322-V-M-Z	570	2,278	2,500*	6671994	SF 3504 V	500	40	—	330890
Shelves					Lane guides made of wire bows				
ZB 341010 V	400	40/ 994	100	145510	DFZB 3403 V	400	30	—	330520
ZB 351010 V	500	40/ 994	100	145520	DFZB 3503 V	500	30	—	330530
ZB 361010 V	600	40/ 994	100	145530	DFZB 3603 V	600	30	—	330540
ZB 381020 V	800	40/ 994	200	145600	DFZB 3803 V	800	30	—	330550
ZB 341315 V	400	40/1,282	150	145540					
ZB 351315 V	500	40/1,282	150	145550					
ZB 361315 V	600	40/1,282	150	145560					
ZB 381325 V	800	40/1,282	250	145630					
Accessories					Accessories				
ZBK 3000 R	Intermediate shelf bracket, right			330360	SBK 3R	Angled shelf bracket, right			330920
ZBK 3000 L	Intermediate shelf bracket, left			330370	SBK 3L	Angled shelf bracket, left			330930
AK 3000	End cap			147130	HUS3-H6x60	Floor fixing set – Screw anchor			6671728
UP3001-V	Packing plate, thickness 1 mm			6671710	SRTS	Load sign**			39070

* The load specifications apply per double-row shelving bay = Basic shelving frame and extension frame

** As per DG-UV-Regel 108-007 where required

Boxes / containers

Modular shelving

Longspan racking

Pallet racking

Cantilever racking

Mezzanines / platforms

On-line shelving / KDR shelving

Semi-automated solutions

Logistics systems

Appendix



LIGHT SILVER

GALVANIZED



Beams



Frame
Shelves
Side rails
Brackets
Adapter

R 7000 on-line shelving

On-line shelving provides a reliable means of storage for any type of containers with diverse dimensions, making them a universal solution.

The high load capacity of max. 2.5 tonnes per bay, flexibility due to the combination of basic and extension bays to create shelving rows, the variability of the shelving depths through the single-row and double-row configurations, along with the cost-effective design, distinguish this popular and proven shelving system from SSI SCHAEFER.

Free-standing dividers can be inserted with a 41 mm spacing pattern to partition the shelving.

Pre-assembled frames and system components that can be assembled without screws enable the shelving to be set up rapidly.

On inclined levels, an end stop beam secures the containers. The side rails prevent goods from falling between the rack frames.

- ▶ **Easy and rapid installation**
- ▶ **Stable and sturdy**
- ▶ **Pre-assembled upright frame** with a 53 mm slot pattern
- ▶ **Rack rows of any desired length**
- ▶ **Starter and extension bay construction**
- ▶ **Inclined shelf levels** gravity-forced sliding to the removal side with improved handling
- ▶ **Height-adjustable shelves**
- ▶ **Single part staging** directly at the assembly work station
- ▶ **First-in-First-out principle (FiFo)**
- ▶ **Reduces costs**

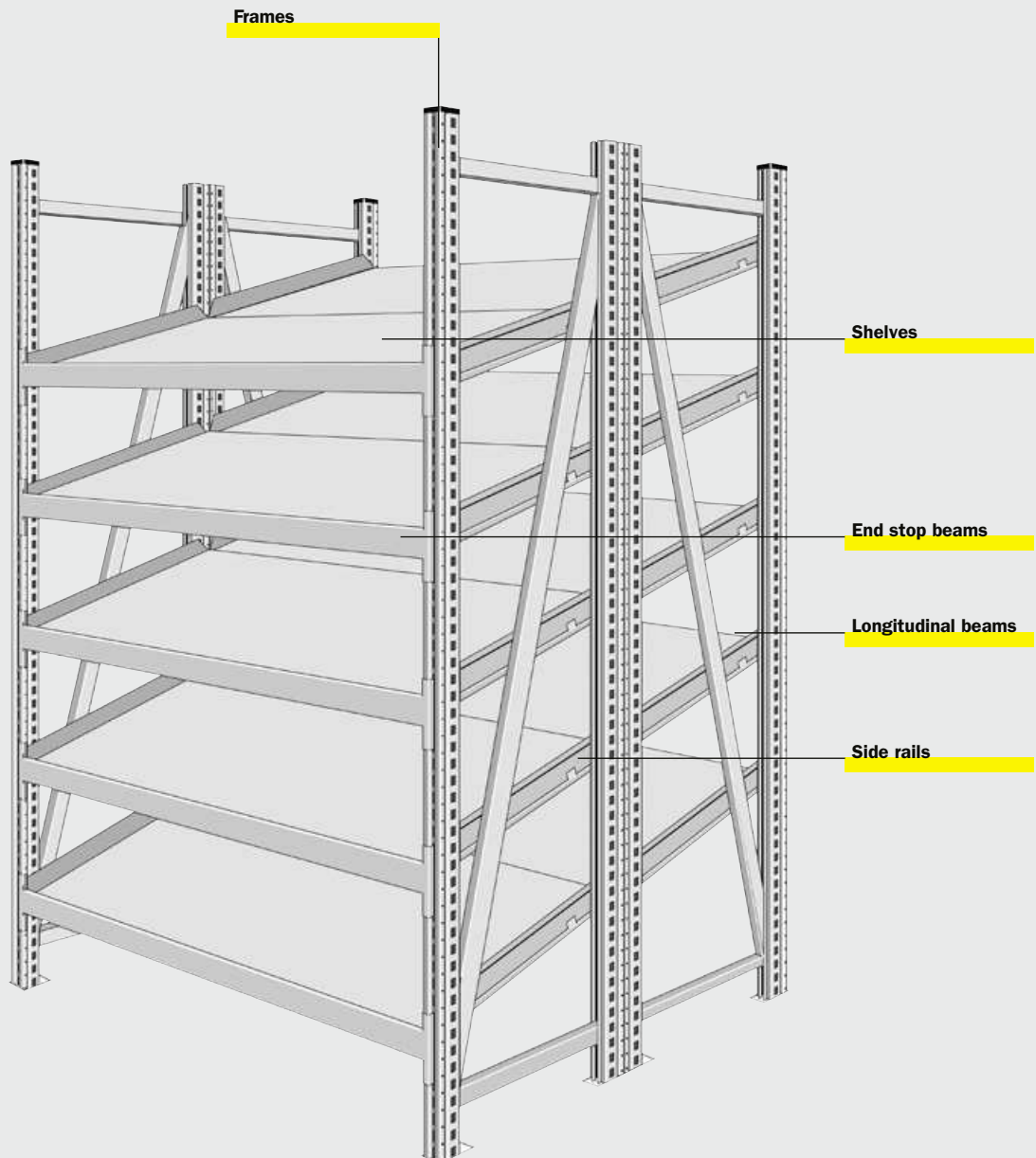

“G” single-row shelving



“G” complete shelving system with 3 flat shelf levels (starter bays) 1,534 mm high

2 pre-assembled upright frames, 6 longitudinal beams, 3 shelves, 6 side rails, 1 load sign.

Item	Usable depth (mm)	Clear bay width (mm)	Max. load per shelf (kg)	Order no.
MBR-740995-GF-G-3	400	995	100	6670905
MBR-741283-GF-G-3		1,283	150	6670909
MBR-750995-GF-G-3	500	995	100	6670906
MBR-751283-GF-G-3		1,283	150	6670910
MBR-760995-GF-G-3	600	995	100	6670907
MBR-761283-GF-G-3		1,283	150	6670911
MBR-780995-GF-G-3	800	995	200	6670908
MBR-781283-GF-G-3		1,283	250	6670912

Extension bays

1 pre-assembled upright frame, 6 longitudinal beams, 3 shelves.

Item	Usable depth (mm)	Clear bay width (mm)	Max. load per shelf (kg)	Order no.
MBR-740995-AF-G-3	400	995	100	6670945
MBR-741283-AF-G-3		1,283	150	6670949
MBR-750995-AF-G-3	500	995	100	6670946
MBR-751283-AF-G-3		1,283	150	6670950
MBR-760995-AF-G-3	600	995	100	6670947
MBR-761283-AF-G-3		1,283	150	6670951
MBR-780995-AF-G-3	800	995	200	6670948
MBR-781283-AF-G-3		1,283	250	6670952

Additional compartment levels

2 longitudinal beams, 1 shelf.

Item	Usable depth (mm)	Clear bay width (mm)	Max. load per shelf (kg)	Order no.
MBR-740995-ZF-G	400	995	100	6670985
MBR-741283-ZF-G		1,283	150	6670989
MBR-750995-ZF-G	500	995	100	6670986
MBR-751283-ZF-G		1,283	150	6670990
MBR-760995-ZF-G	600	995	100	6670987
MBR-761283-ZF-G		1,283	150	6670991
MBR-780995-ZF-G	800	995	200	6670988
MBR-781283-ZF-G		1,283	250	6670992

Order no. = on stock

“G” complete shelving system with 5 flat shelf levels (starter bays) 2,170 mm high

2 pre-assembled upright frames, 10 longitudinal beams, 5 shelves, 10 side rails, 1 load sign.

Item	Usable depth (mm)	Clear bay width (mm)	Max. load per shelf (kg)	Order no.
MBR-740995-GF-G-5	400	995	100	6670913
MBR-741283-GF-G-5		1,283	150	6670917
MBR-750995-GF-G-5	500	995	100	6670914
MBR-751283-GF-G-5		1,283	150	6670918
MBR-760995-GF-G-5	600	995	100	6670915
MBR-761283-GF-G-5		1,283	150	6670919
MBR-780995-GF-G-5	800	995	200	6670916
MBR-781283-GF-G-5		1,283	250	6670920

Extension bays

1 pre-assembled upright frame, 10 longitudinal beams, 5 shelves.

Item	Usable depth (mm)	Clear bay width (mm)	Max. load per shelf (kg)	Order no.
MBR-740995-AF-G-5	400	995	100	6670953
MBR-741283-AF-G-5		1,283	150	6670957
MBR-750995-AF-G-5	500	995	100	6670954
MBR-751283-AF-G-5		1,283	150	6670958
MBR-760995-AF-G-5	600	995	100	6670955
MBR-761283-AF-G-5		1,283	150	6670959
MBR-780995-AF-G-5	800	995	200	6670956
MBR-781283-AF-G-5		1,283	250	6670960

Additional compartment levels

2 longitudinal beams, 1 shelf.

Item	Usable depth (mm)	Clear bay width (mm)	Max. load per shelf (kg)	Order no.
MBR-740995-ZF-G	400	995	100	6670985
MBR-741283-ZF-G		1,283	150	6670989
MBR-750995-ZF-G	500	995	100	6670986
MBR-751283-ZF-G		1,283	150	6670990
MBR-760995-ZF-G	600	995	100	6670987
MBR-761283-ZF-G		1,283	150	6670991
MBR-780995-ZF-G	800	995	200	6670988
MBR-781283-ZF-G		1,283	250	6670992

Boxes / containers

Modular shelving

Longspan racking

Pallet racking

Cantilever racking

Mezzanines / platforms

On-line shelving / KDR shelving

Semi-automated solutions

Logistics systems

Appendix

“S” single-row shelving



Example with 5 levels
Offer without containers

“S” complete shelving system with 3 tilted shelf levels (starter bays) 1,534 mm high

2 pre-assembled upright frames, 3 longitudinal and 3 end stop beams, 3 shelves, 6 side rails, 1 load sign.

Item	Usable depth (mm)	Clear bay width (mm)	Max. load per shelf (kg)	Order no.
MBR-740995-GF-S-3	400	995	100	6670921
MBR-741283-GF-S-3		1,283	150	6670925
MBR-750995-GF-S-3	500	995	100	6670922
MBR-751283-GF-S-3		1,283	150	6670926
MBR-760995-GF-S-3	600	995	100	6670923
MBR-761283-GF-S-3		1,283	150	6670927
MBR-780995-GF-S-3	800	995	200	6670924
MBR-781283-GF-S-3		1,283	250	6670928

Extension bays

1 pre-assembled upright frame, 3 longitudinal and 3 end stop beams, 3 shelves.

Item	Usable depth (mm)	Clear bay width (mm)	Max. load per shelf (kg)	Order no.
MBR-740995-AF-S-3	400	995	100	6670961
MBR-741283-AF-S-3		1,283	150	6670965
MBR-750995-AF-S-3	500	995	100	6670962
MBR-751283-AF-S-3		1,283	150	6670966
MBR-760995-AF-S-3	600	995	100	6670963
MBR-761283-AF-S-3		1,283	150	6670967
MBR-780995-AF-S-3	800	995	200	6670964
MBR-781283-AF-S-3		1,283	250	6670968

Additional compartment levels

1 longitudinal and 1 end stop beam, 1 shelf.

Item	Usable depth (mm)	Clear bay width (mm)	Max. load per shelf (kg)	Order no.
MBR-740995-ZF-S	400	995	100	6670993
MBR-741283-ZF-S		1,283	150	6670997
MBR-750995-ZF-S	500	995	100	6670994
MBR-751283-ZF-S		1,283	150	6670998
MBR-760995-ZF-S	600	995	100	6670995
MBR-761283-ZF-S		1,283	150	6670999
MBR-780995-ZF-S	800	995	200	6670996
MBR-781283-ZF-S		1,283	250	6671000

“S” complete shelving system with 5 tilted shelf levels (starter bays) 2,170 mm high

2 pre-assembled upright frames, 5 longitudinal and 5 end stop beams, 5 shelves, 10 side rails, 1 load sign.

Item	Usable depth (mm)	Clear bay width (mm)	Max. load per shelf (kg)	Order no.
MBR-740995-GF-S-5	400	995	100	6670929
MBR-741283-GF-S-5		1,283	150	6670933
MBR-750995-GF-S-5	500	995	100	6670930
MBR-751283-GF-S-5		1,283	150	6670934
MBR-760995-GF-S-5	600	995	100	6670931
MBR-761283-GF-S-5		1,283	150	6670935
MBR-780995-GF-S-5	800	995	200	6670932
MBR-781283-GF-S-5		1,283	250	6670936

Extension bays

1 pre-assembled upright frame, 5 longitudinal and 5 end stop beams, 5 shelves.

Item	Usable depth (mm)	Clear bay width (mm)	Max. load per shelf (kg)	Order no.
MBR-740995-AF-S-5	400	995	100	6670969
MBR-741283-AF-S-5		1,283	150	6670973
MBR-750995-AF-S-5	500	995	100	6670970
MBR-751283-AF-S-5		1,283	150	6670974
MBR-760995-AF-S-5	600	995	100	6670971
MBR-761283-AF-S-5		1,283	150	6670975
MBR-780995-AF-S-5	800	995	200	6670972
MBR-781283-AF-S-5		1,283	250	6670976

Additional compartment levels

1 longitudinal and 1 end stop beam, 1 shelf.

Item	Usable depth (mm)	Clear bay width (mm)	Max. load per shelf (kg)	Order no.
MBR-740995-ZF-S	400	995	100	6670993
MBR-741283-ZF-S		1,283	150	6670997
MBR-750995-ZF-S	500	995	100	6670994
MBR-751283-ZF-S		1,283	150	6670998
MBR-760995-ZF-S	600	995	100	6670995
MBR-761283-ZF-S		1,283	150	6670999
MBR-780995-ZF-S	800	995	200	6670996
MBR-781283-ZF-S		1,283	250	6671000

Order no. = on stock



- ▶ **Height-adjustable**
shelves with a 53 mm hole pattern
- ▶ **Single part provision**
directly at the assembly work station
- ▶ **First-in-First-out principle**

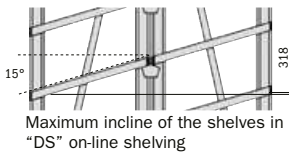

"DS" double-row shelving



Example with 5 levels
Offer without containers

"DS" complete shelving system with 3 tilted shelf levels (starter bays) 1,534 mm high

4 pre-assembled upright frames, 3 longitudinal and 3 end stop beams, 6 shelf brackets, 6 bracket adapters, 6 shelves, 12 side rails, 1 load sign.

Item	Usable depth (mm)	Clear bay width (mm)	Max. load per shelf (kg)	Order no.
MBR-750995-GF-DS-3	1,000	995	100	6670937
MBR-751283-GF-DS-3		1,283	150	6670939
MBR-760995-GF-DS-3	1,200	995	100	6670938
MBR-761283-GF-DS-3		1,283	150	6670940

Extension bays

2 pre-assembled upright frames, 3 longitudinal and 3 end stop beams, 6 shelf brackets, 6 bracket adapters, 6 shelves.

Item	Usable depth (mm)	Clear bay width (mm)	Max. load per shelf (kg)	Order no.
MBR-750995-AF-DS-3	1,000	995	100	6670977
MBR-751283-AF-DS-3		1,283	150	6670979
MBR-760995-AF-DS-3	1,200	995	100	6670978
MBR-761283-AF-DS-3		1,283	150	6670980

Additional compartment levels

1 longitudinal and 1 end stop beam, 2 shelf brackets, 2 bracket adapters, 2 shelves.

Item	Usable depth (mm)	Clear bay width (mm)	Max. load per shelf (kg)	Order no.
MBR-750995-ZF-DS	1,000	995	100	6671001
MBR-751283-ZF-DS		1,283	150	6671003
MBR-760995-ZF-DS	1,200	995	100	6671002
MBR-761283-ZF-DS		1,283	150	6671004

"DS" complete shelving system with 5 tilted shelf levels (starter bays) 2,170 mm high

4 pre-assembled upright frames, upright 5 longitudinal and 5 end stop beams, 10 shelf brackets, 10 bracket adapters, 10 shelves, 20 side rails, 1 load sign.

Item	Usable depth (mm)	Clear bay width (mm)	Max. load per shelf (kg)	Order no.
MBR-750995-GF-DS-5	1,000	995	100	6670941
MBR-751283-GF-DS-5		1,283	150	6670943
MBR-760995-GF-DS-5	1,200	995	100	6670942
MBR-761283-GF-DS-5		1,283	150	6670944

Extension bays

2 pre-assembled upright frames, 5 longitudinal and 5 end stop beams, 10 shelf brackets, 10 bracket adapters, 10 shelves.

Item	Usable depth (mm)	Clear bay width (mm)	Max. load per shelf (kg)	Order no.
MBR-750995-AF-DS-5	1,000	995	100	6670981
MBR-751283-AF-DS-5		1,283	150	6670983
MBR-760995-AF-DS-5	1,200	995	100	6670982
MBR-761283-AF-DS-5		1,283	150	6670984

Additional compartment levels

1 longitudinal and 1 end stop beam, 2 shelf brackets, 2 bracket adapters, 2 shelves.

Item	Usable depth (mm)	Clear bay width (mm)	Max. load per shelf (kg)	Order no.
MBR-750995-ZF-DS	1,000	995	100	6671001
MBR-751283-ZF-DS		1,283	150	6671003
MBR-760995-ZF-DS	1,200	995	100	6671002
MBR-761283-ZF-DS		1,283	150	6671004

Note: Due to technical reasons, the front and rear levels of double-row designs may have slightly different angles.

Boxes / containers

Modular shelving

Longspan racking

Pallet racking

Cantilever racking

Mezzanines / platforms

On-line shelving / KDR shelving

Semi-automated solutions

Logistics systems

Appendix

Individual components



Individual components for the "G, S, DS" on-line shelving				
Item	Usable depth (mm)	Height/Length (mm)	Load (max. kg)	Order no.
Frames				
RRL 7401 V	400	1,534	2,500	39205
RRL 7501 V	500	1,534	2,500	39215
RRL 7601 V	600	1,534	2,500	39225
RRL 7801 V	800	1,534	2,500	39235
RRL 7402 V	400	2,170	2,500	39950
RRL 7502 V	500	2,170	2,500	76610
RRL 7602 V	600	2,170	2,500	39200
RRL 7802 V	800	2,170	2,500	38900
Longitudinal beams				
LTR 7099	400 - 800	995	250	39250
LTR 7128	400 - 800	1,283	250	39260
End stop beams				
ATR 74099	400	995	250	39980
ATR 7099	500 - 800	995	250	39220
ATR 74128	400	1,283	250	39990
ATR 7128	500 - 800	1,283	250	39230
Shelves				
ZB 4413 V	400	30/ 995	100	27012
ZB 4513 V	500	30/1,283	150	27032
ZB 4613 V	600	30/ 995	100	27072
ZB 4823 V	800	30/1,283	150	27172
ZB 9415 V	400	30/ 995	100	38102
ZB 9515 V	500	30/1,283	150	38112
ZB 9615 V	600	30/ 995	200	38132
ZB 9825 V	800	30/1,283	250	38282
Side rails				
SF 3404	400	40	-	330880
SF 3504	500	40	-	330890
SF 3604	600	40	-	330900
SF 3804	800	40	-	330910
Accessories				
ZBK 7000	Shelf bracket for DS design			39280
KA 7000	Bracket adapter for DS design			39290
ZBT 7000	Shelf support* (4 pcs. per shelf)			38930
AK 7000	Cover caps for rack frames			29350
SRTS	Load sign**			39070

* Only usable for level shelves in combination with at least 3 reinforcing beam levels

** As per DG-UV-Regel 108-007 where required



Undercarriage for R 7000 glide real on-line shelving

For easily relocating basic shelving units. Consisting of 2 beams, 1 cross brace and 4 swivel castors, 2 with lock. Load capacity per undercarriage 500 kg.

Item	Bay width (mm)	Frame depth (mm)	Order no.
TFW 70610	995	600	321300
TFW 70810		800	321301
TFW 71010		1,000	321302
TFW 71210		1,200	321303
TFW 70613	1,283	600	321304
TFW 70813		800	321305
TFW 71013		1,000	321306
TFW 71213		1,200	321307

Undercarriage for modular shelvings

Enables easy relocation of basic shelving units when unloaded.

Consisting of 4 swivel castors, 2 with locks. Bolted assembly with adapter plate directly underneath the supports. One beam and 4 frame connectors are delivered for the required reinforcement. In addition, 2 sliding bars made of plastic are included in the delivery.



Safety note:
Shelving units may only be moved when unloaded.

Item	Bay width (mm)	Height (mm)	Load max. (kg)	Order no.
FW 70995	995	155	500	79210
FW 71283	1,283	155	500	79220

Order no. = on stock



R 7000 on-line shelving

Appendix	Logistics systems	Semi-automated solutions	On-line shelving / KDR shelving	Mezzanines / platforms	Cantilever racking	Pallet racking	Longspan racking	Modular shelving	Boxes / containers
----------	-------------------	--------------------------	---------------------------------	------------------------	--------------------	----------------	------------------	------------------	--------------------

KDR – the live storage shelving system with diverse options



Stable and sturdy frames connected to reinforcing beams create a “rack scaffold” for fitting complete live storage shelving units. The height and angle of the flow beds can be quickly adjusted without screws using adjusting hooks in steps of 6.25 mm (post type P63/P65) or 12.5 mm (post type P73/P93) and also horizontally in 25 mm steps.

The staircase design of the flow beds with outfeed panels or enabled geometry can fulfill all ergonomic requirements.

Transverse transport conveyors can be connected cost-effectively using underlays placed on the supports.

Robust roller tracks in various designs guarantee problem-free movement of the containers from the supply to the removal side. The use of various

separating strip systems enables the configuration of guides (channels) for the specific load carrier types.

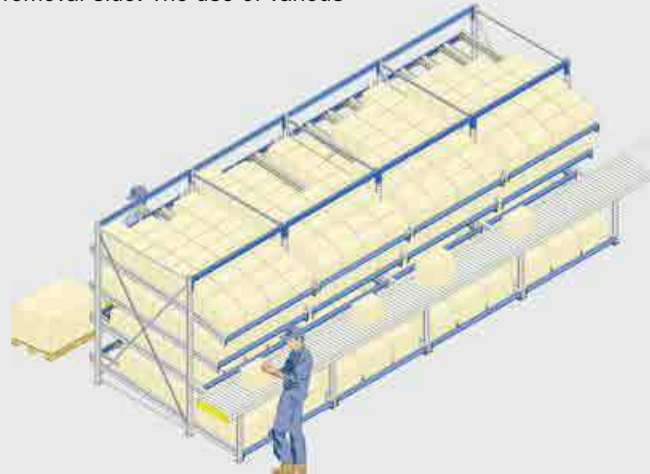

KDR system design – stationary

GENTIAN BLUE Beams
RAL 5010

GALVANIZED Frame
Glide rails
Brackets
Adapter

- ▶ **High load capacity**
and high rigidity due to sturdy support, 60, 75 and 90 mm thick
- ▶ **System hole pattern**
in the upright profiles with adjustment spacing 50 : 50 mm
- ▶ **The best height and gradient adjustment**
of the flow bed to the storage goods due to the small hole pattern, e.g. 6.25 mm
- ▶ **Plug-in anti-lifting device**
- ▶ **Flexible and modular bold-free system**
due to adjustable rolls and partitions for configuring channels with a spacing of 5 mm per roll
- ▶ **Roller tracks for smooth conveying**
optionally with a load capacity of 5 kg and 12 kg
- ▶ **Can be combined**
with other SSI SCHAEFER rack systems
- ▶ **Easy connection**
to all conveyor systems
- ▶ **Vast range of accessories**



Starter and extension bay construction

The stationary design is available with either the starter or extension bay construction

Anchoring the uprights to the floor prevents the bays from slipping and provides additional stability.

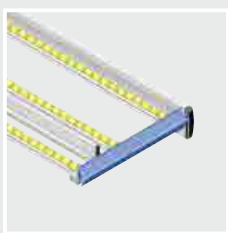
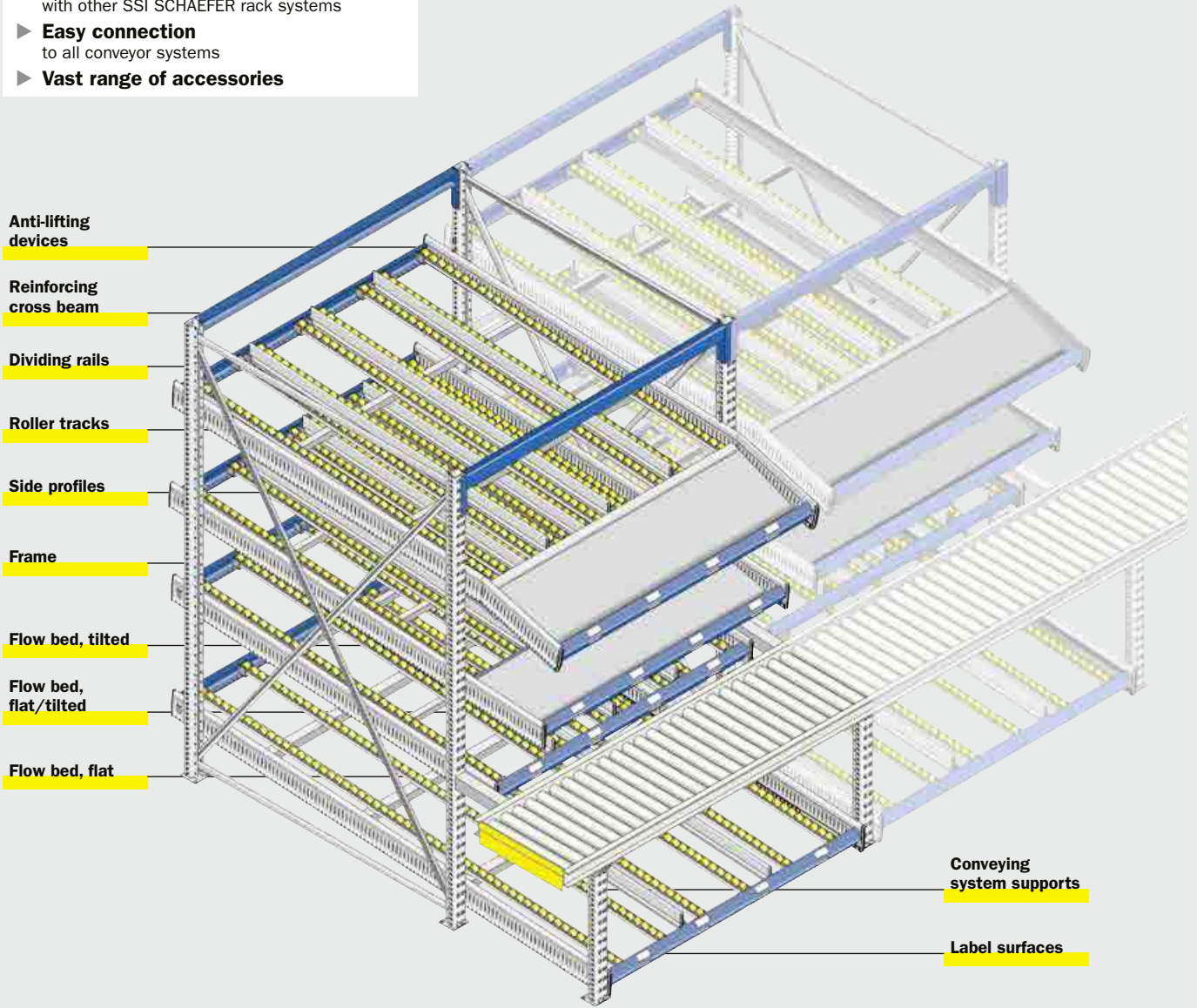

Flow bed, flat



Flow bed, flat/tilted



Flow bed, tilted

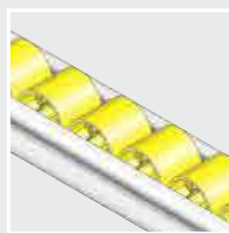

Roller track



Dividing rail

Boxes / containers

Modular shelving

Longspan racking

Pallet racking

Cantilever racking

Mezzanines / platforms

On-line shelving / KDR shelving

Semi-automated solutions

Logistics systems

Appendix

KDR/KLT live storage – the system for KLT containers



Further information about the KDR system

on request



GENTIAN BLUE

GALVANIZED



Beams
Lateral connectors
(front and rear)



Frame
Outfeed panel
Side profiles

- ▶ **High load capacity**
and high rigidity due to sturdy support, 60, 75 and 90 mm thick
- ▶ **System hole pattern**
in the upright profiles with adjustment spacing 50 : 50 mm
- ▶ **The best height and gradient adjustment**
of the flow bed to the storage goods due to the small hole pattern, e.g. 6.25 mm
- ▶ **Plug-in anti-lifting device**
- ▶ **Flexible and modular bolt-free system**
due to adjustable rolls and partitions for configuring channels with a spacing of 5 mm
- ▶ **Roller tracks for smooth conveying**
optionally with a load capacity of 5 kg and 12 kg
- ▶ **Can be combined**
with other SSI SCHAEFER rack systems
- ▶ **Easy connection**
to all conveyor systems
- ▶ **Vast range of accessories**

KDR/KLT – with undercarriage

Starter bay construction

The movable units are constructed using starter bays.

For containers with a “honeycomb base” (C-KLTs with grooves) and containers with a large stacking rim, there is a KLT model for the special requirements.

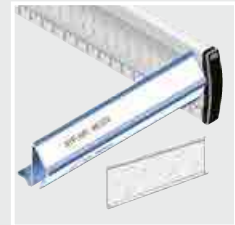

Lateral connectors, front

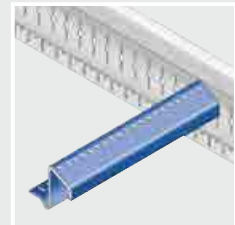

Lateral connectors, tilted

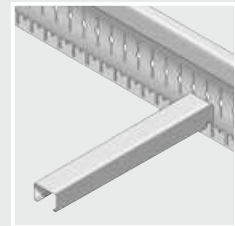

Lateral connectors, internal

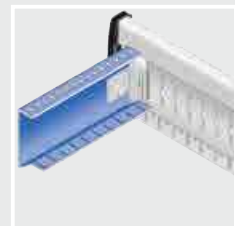

Lateral connectors, rear KLT

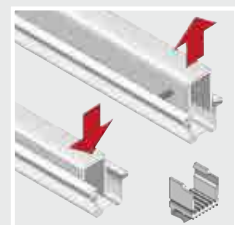

Retractable dividing rail with docking clip

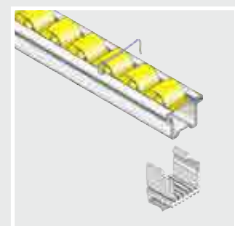

Roller track with brake clip and brake strap

Boxes / containers

Modular shelving

Longspan racking

Pallet racking

Cantilever racking

Mezzanines / platforms

On-line shelving / KDR shelving

Semi-automated solutions

Logistics systems

Appendix

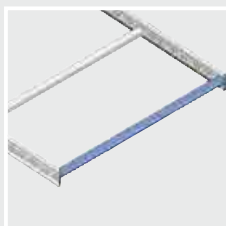
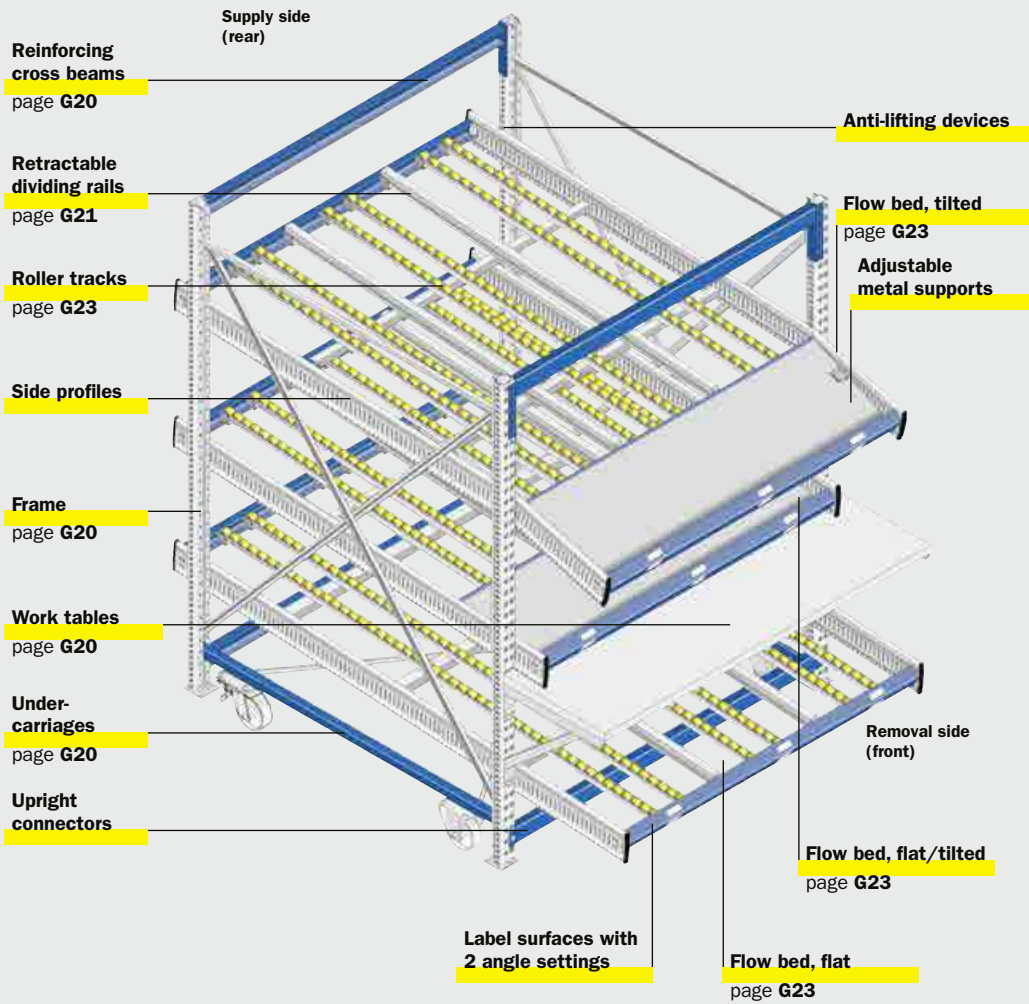

Flow bed, flat

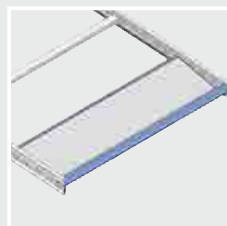

Flow bed, flat/tilted

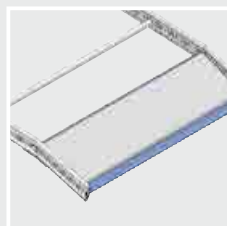

Flow bed, tilted



Anti-lifting device Cover caps

KDR/KLT live storage shelving – conductive design (ESD) for protecting high-quality electronic components

Protection against electrostatic discharge

Protection against electrostatic discharge creates special requirements for shelving equipment. According to EN 61340-5-1:2001 it is essential that all of the individual measures for handling these sensitive components are effectively coordinated with each other.

In particular, this applies to the packaging of the electronic components, the transport containers, the shelving equipment, the conduct of flooring or the Echo potential bonding and, not least, the protective clothing worn by the employees working in ESD areas.



i Further information about the KDR system in conductive design (ESD)

on request

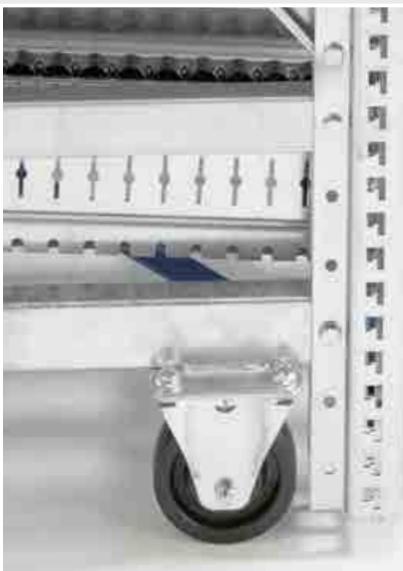

Fixed castor, conductive



Dividing rails and conductive roller tracks



Swivel castor with stopper

GENTIAN BLUE

GALVANIZED



Beams



Frame
Lateral connector
Undercarriage beams
Outfeed panels

- ▶ **High load capacity** and high rigidity due to sturdy uprights, 60, 75 and 90 mm thick
- ▶ **System hole pattern** in the upright profiles with adjustment spacing 50 : 50 mm
- ▶ **The best height and gradient adjustment** of the flow bed to the storage goods due to the small hole pattern, e.g. 6.25 mm
- ▶ **Plug-in anti-lifting device**
- ▶ **Flexible and modular bolt-free system** due to adjustable rolls and partitions for configuring channels with a spacing of 5 mm
- ▶ **Roller tracks for smooth conveying** with a load capacity of 12 kg
- ▶ **Highly conductive rollers** black, with steel axles
- ▶ **Can be combined** with other SSI SCHAEFER rack systems
- ▶ **Easy connection** to all conveyor systems
- ▶ **Vast range of accessories**
- ▶ **Quality tested and certified** by TÜV Rheinland



KDR/KLT system design for ESD version – with undercarriage

Boxes / containers

Modular shelving

Longspan racking

Pallet racking

Cantilever racking

Mezzanines / platforms

On-line shelving / KDR shelving

Semi-automated solutions

Logistics systems

Appendix

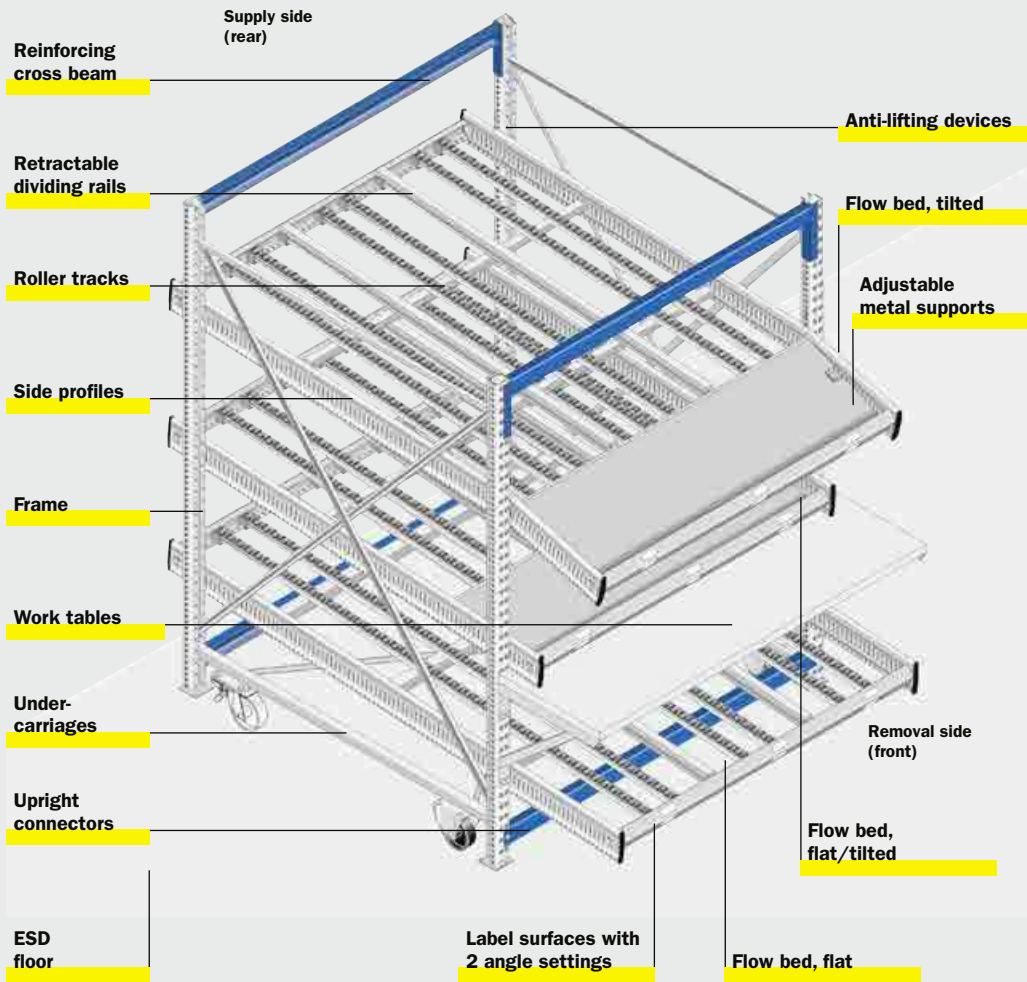

Lateral connectors, front

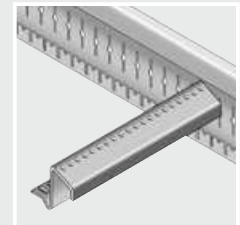

Lateral connectors, tilted

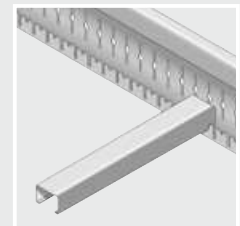

Lateral connectors, internal

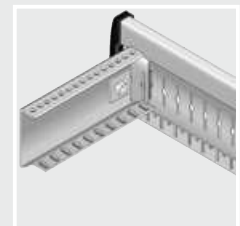

Lateral connectors, rear KLT

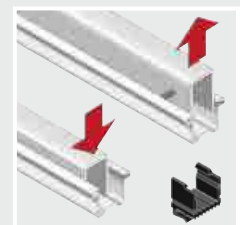

Retractable dividing rail with docking clip

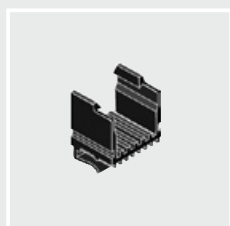

Docking clip, conductive

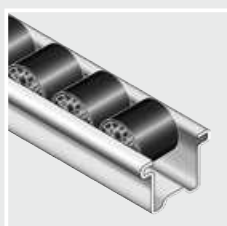

Roller track, conductive



Fixed castor, conductive



Undercarriage, conductive

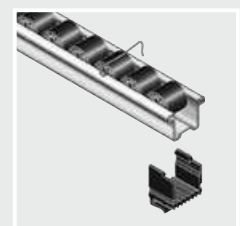

Roller track with brake clip and brake strap

i

GENTIAN BLUE
RAL 5010

GALVANIZED

Beams
Lateral connectors
(front and rear)

Frame
Side profiles
Lateral connectors
(internal)
Roller and partition strips

KDR live storage shelving with European dimensions – complete shelving units for container sizes 300 x 400 mm / 200 x 300 mm

- ▶ **Stable**
sturdy upright frame, 3 reinforcing cross beams per bay, floor fixing
- ▶ **Rollers**
with plastic axles, load capacity 5 kg per individual roller

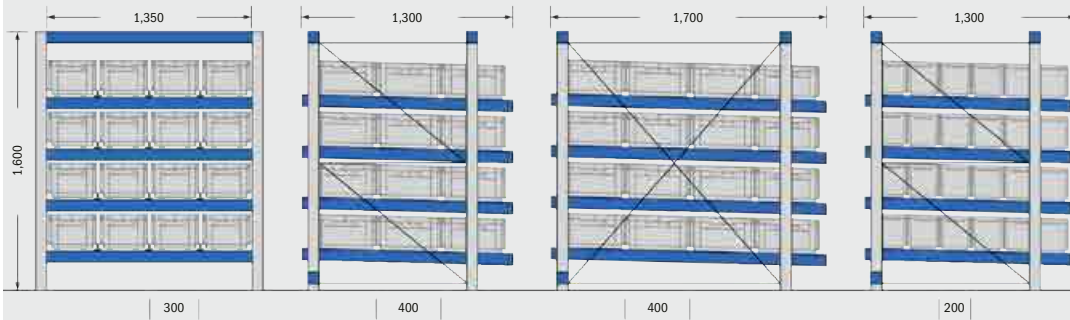

KDR complete shelving system – starter bays

Consisting of 2 frames and 3 reinforcing cross beams.

Equipment for each shelving bay:
4 flat flow beds above each other;
8 roller tracks per flow bed, 28 mm divisions;
3 standard dividing rails per flow bed.

Clear bay width 1,350 mm, clear channel width 310 mm, total width 1,470 mm, height 1,600 mm

Item	Total depth (mm)	Load capacity live storage level (kg)	Flow bed version	Order no.
K-GF-1350-1300-4-BG01	1,300	180	Flat	464300
K-GF-1350-1700-4-BG01	1,700	270	Flat	464310
additional flow beds				
K-DLR-1350-1300-BG01	1,300	180	Flat	464320
K-DLR-1350-1700-BG01	1,700	270	Flat	464330

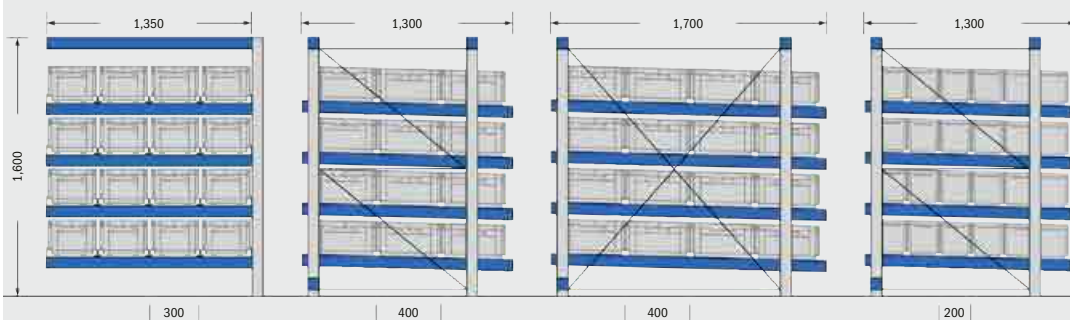

KDR complete shelving system – extension bays

Consisting of 1 frames and 3 reinforcing cross beams.

Equipment for each shelving bay:
4 tilted flow beds above each other;
8 roller tracks per flow bed, 28 mm divisions;
3 standard dividing rails per flow bed.

Clear bay width 1,350 mm, clear channel width 310 mm, total width 1,410 mm, height 1,600 mm

Item	Total depth (mm)	Load capacity live storage level (kg)	Flow bed version	Order no.
K-AF-1350-1300-4-BG01	1,300	180	Flat	464340
K-AF-1350-1700-4-BG01	1,700	270	Flat	464350
additional flow beds				
K-DLR-1350-1300-BG01	1,300	180	Flat	464320
K-DLR-1350-1700-BG01	1,700	270	Flat	464330

Order no. = on stock

KDR live storage shelving with European dimensions – complete shelving units for container sizes 600 x 400 mm

► **Flow bed, flat**
 angle adjustable in 6,25 mm steps
 depth adjustable in 25 mm steps,
 can also be used as a return level

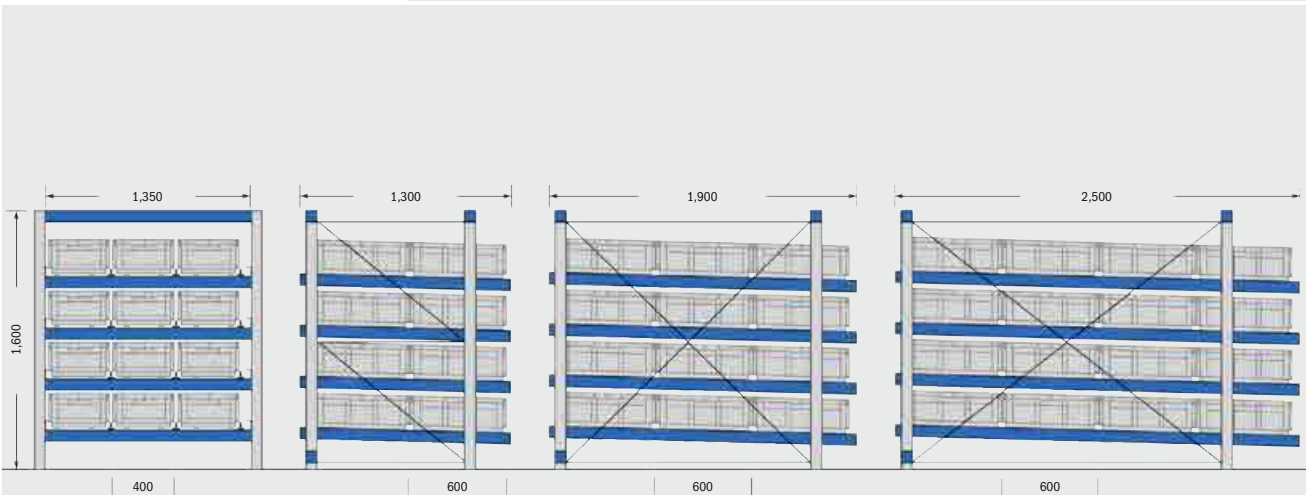

Clear bay width 1,350 mm, clear channel width 410 mm, total width 1,470 mm, height 1,600 mm

Item	Total depth (mm)	Load capacity live storage level (kg)	Flow bed version	Order no.
K-GF-1350-1300-4-BG02	1,300	180	Flat	464360
K-GF-1350-1900-4-BG02	1,900	270	Flat	464370
K-GF-1350-2500-4-BG02	2,500	360	Flat	464380
additional flow beds				
K-DLR-1350-1300-BG02	1,300	180	Flat	464390
K-DLR-1350-1900-BG02	1,900	270	Flat	464400
K-DLR-1350-2500-BG02	2,500	360	Flat	464410

KDR complete shelving system – starter bays

Consisting of 2 frames and 3 reinforcing cross beams.

Equipment for each shelving bay:
 4 tilted flow beds above each other;
 6 roller tracks per flow bed, 28 mm divisions;
 3 standard dividing rails per flow bed.

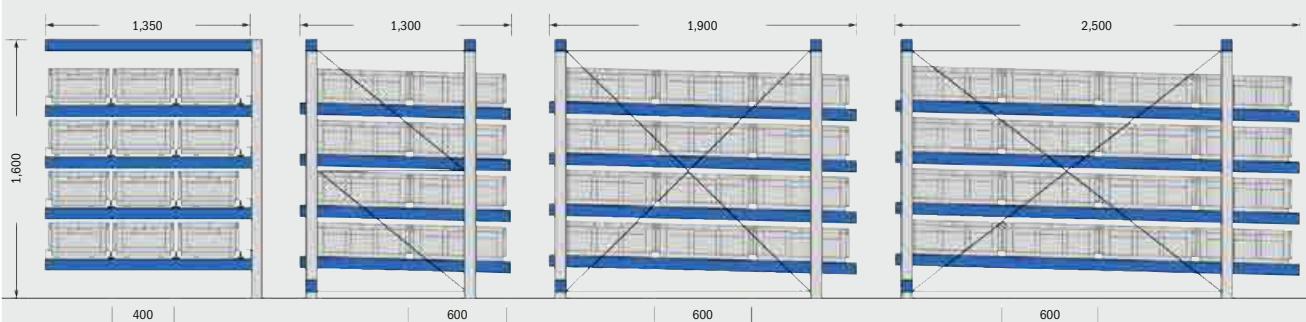

Clear bay width 1,350 mm, clear channel width 410 mm, total width 1,410 mm, height 1,600 mm

Item	Total depth (mm)	Load capacity live storage level (kg)	Flow bed version	Order no.
K-AF-1350-1300-4-BG02	1,300	180	Flat	464420
K-AF-1350-1900-4-BG02	1,900	270	Flat	464430
K-AF-1350-2500-4-BG02	2,500	360	Flat	464440
additional flow beds				
K-DLR-1350-1300-BG02	1,300	180	Flat	464390
K-DLR-1350-1900-BG02	1,900	270	Flat	464400
K-DLR-1350-2500-BG02	2,500	360	Flat	464410

KDR complete shelving system – extension bays

Consisting of 1 frames and 3 reinforcing cross beams.

Equipment for each shelving bay:
 4 tilted flow beds above each other;
 6 roller tracks per flow bed, 28 mm divisions;
 3 standard dividing rails per flow bed.

Boxes / containers

Modular shelving

Longspan racking

Pallet racking

Cantilever racking

Mezzanines / platforms

On-line shelving / KDR shelving

Semi-automated solutions

Logistics systems

Appendix

System components

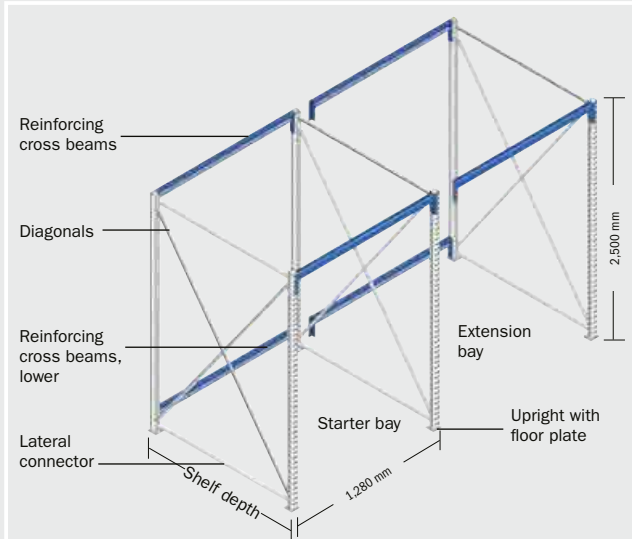

Starter and extension bays

Starter bays consisting of 2 frames and 3 horizontal beams; extension bays consisting of 1 frame and 3 horizontal beams.



End caps

High-quality black plastic. Attached to the rack uprights as an end piece.

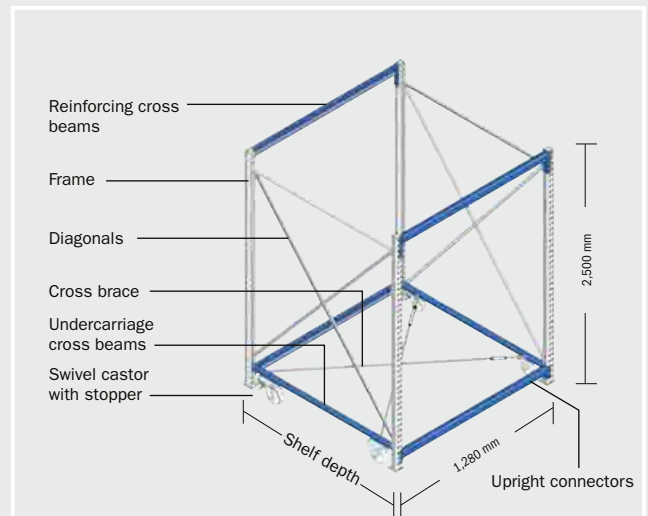
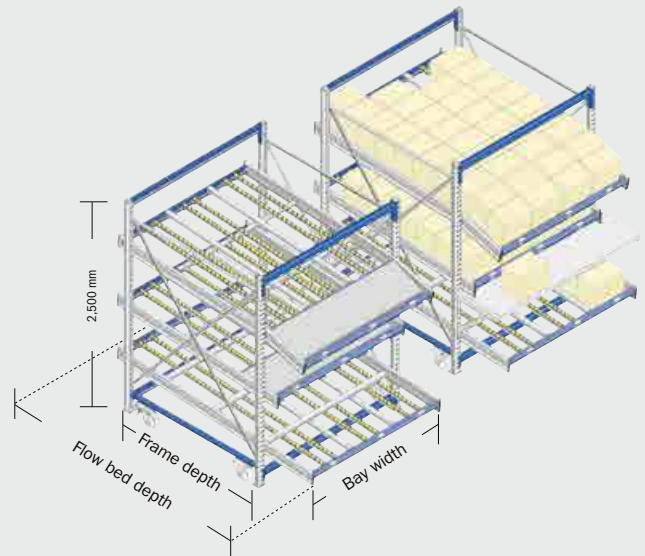

Starter bay with undercarriage

Consisting of 2 frames and 2 cross beams, 2 upright connectors, 2 undercarriage cross beam, 1 cross brace, 2 fixed and 2 swivel castors with stoppers. Load capacity per rack bay with undercarriage max. 1,600 kg.

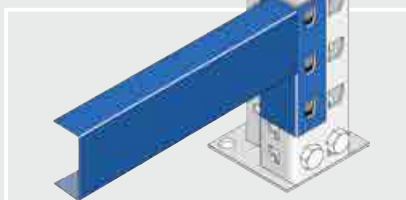

Reinforcing cross beam (U-profile) for upright profiles P 63, P 65 and P 73

Reinforcing cross beams and uprights form a separate unit. This separates the supporting shelving construction from the live storage levels. As a consequence, a level can be adjusted without having to first storage empty the entire shelving.

The cross beams only serve to reinforce the rack construction and are not intended for storing pallets. Additional reinforcing cross beams are fitted at the rear in accordance with the static requirements.

Surface finish: Gentian Blue, RAL 5010.

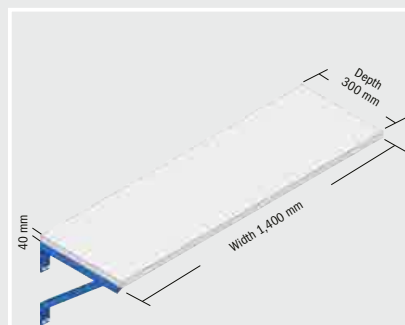

Work table

For pre-assembly or storage. 2 cantilever supports and 1 multiplex board, 40 mm thick.

Cantilever surface finish: Gentian Blue, RAL 5010.

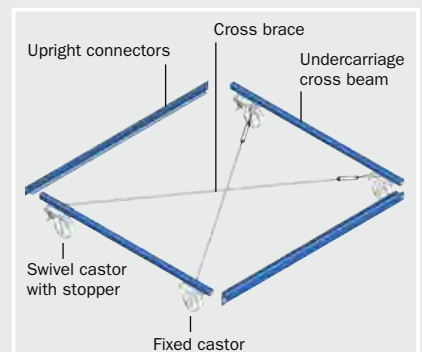

Undercarriage

Enables easy relocation of starter bays.

Equipped with 2 upright connectors, 2 undercarriage cross beam, 1 cross brace, 2 fixed castors and 2 swivel castors with stoppers.

Load capacity per shelving bay with undercarriage: max. 1,600 kg.

Surface finish: Gentian Blue, RAL 5010.

- ▶ Can be combined with existing pallet racking systems
- ▶ Shorter paths
- ▶ Time savings
- ▶ Better ergonomics and rapid access
- ▶ Clear product range
- ▶ Automatic resupply of goods
- ▶ First-in-First-out
- ▶ Separate supply and removal procedures

KDR adapter solutions for pallet racking systems, partition strips

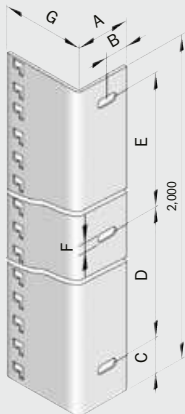
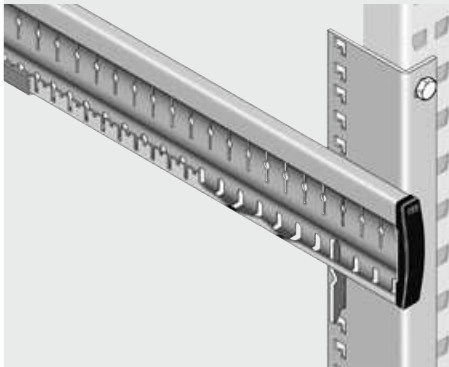

Support adapter, left



Support adapter

For fastening on rack uprights of existing pallet racking systems – PR 350 and third-party brands. For quick and easy retrofitting with flow beds.

The profiles of the support adapters are individually adapted to the pallet racking uprights.

Article on request.

When submitting an inquiry, please specify the following dimensions and existing rack brand/type:

Dimensions	A (mm)	B (mm)	C (mm)	D (mm)	E (mm)	F (mm)	G (mm)
	<input type="text"/>	<input type="text"/>	<input type="text"/>	<input type="text"/>	<input type="text"/>	<input type="text"/>	<input type="text"/>

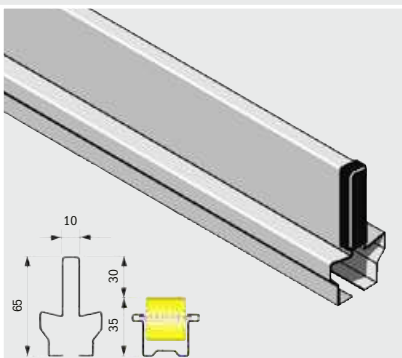

Standard dividing rails

Made of steel, prevent two stored items running next to each other from jamming. They can be adjusted in 5.0 mm steps and are equipped with protective plugs to prevent hand injuries.

Surface, galvanized.

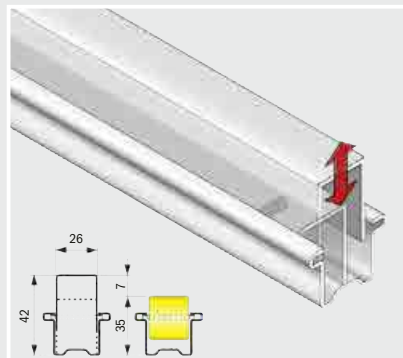

Recessed dividing rails

For the universal use of KLT containers.

Surface, galvanized

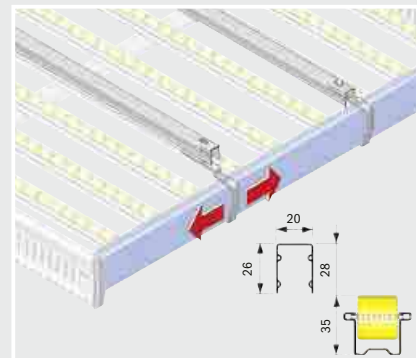

Multi dividing rails/clips

Multi dividing rails can be adjusted horizontally in 10 mm steps. Ideal in combination with a roller carpet for frequently changing storage goods.

Surface, galvanized

Further information about the KDR system

on request

Boxes / containers

Modular shelving

Longspan racking

Pallet racking

Cantilever racking

Mezzanines / platforms

On-line shelving / KDR shelving

Semi-automated solutions

Logistics systems

Appendix

KLT flow bed with recessed dividing rail

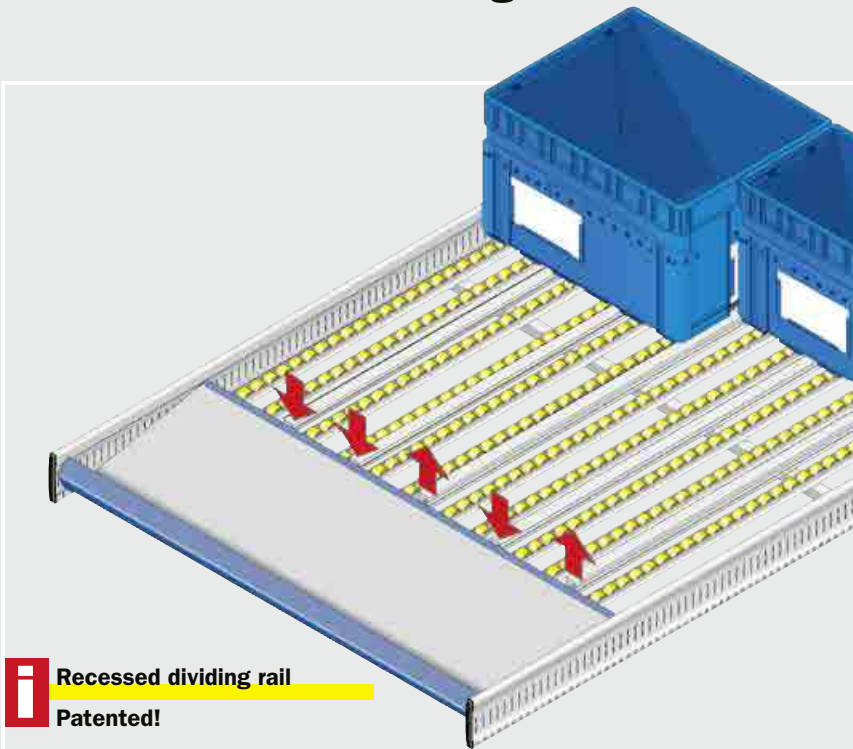

i Recessed dividing rail
Patented!

Example for clear bay width of 1,280 mm

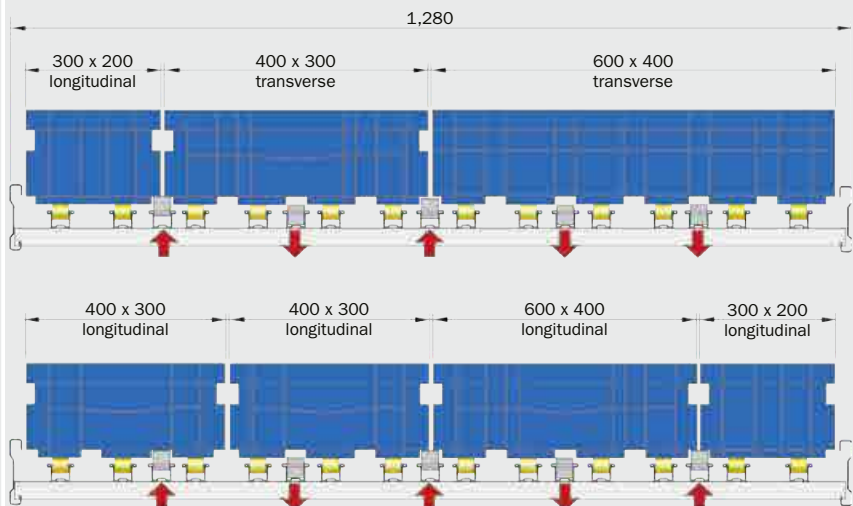

Retracting or extending the dividing rail enables containers with different dimensions to be mixed on one level



i	GENTIAN BLUE	GALVANIZED
	Beams	
RAL 5010		Frame Glide rails Brackets Adapter

- ▶ **Always the right channel widths** for system containers with 200/400 mm or 300/600 mm standard dimensions through the use of partition strips that can be recessed quickly and without using tools. There is no need to move the partition or roller tracks.
- ▶ **Harmonized rack dimensions** for all KLT container sizes
- ▶ **Easy assembly and adjustment using the bolt-free system**
- ▶ **Usable without conversion** as a conventional live storage shelving
- ▶ **Harmonized system profiles** prevent the container base from jamming
- ▶ **Gradient and height adjustment** in 6.25 mm steps
- ▶ **Without depth restriction** when adjusting the gripping curve
- ▶ **Flow bed with plug-in anti-lifting device**
- ▶ **Locking spreader for roller tracks**
- ▶ **Roller tracks** optionally with steel axle, 12 kg load capacity per roller

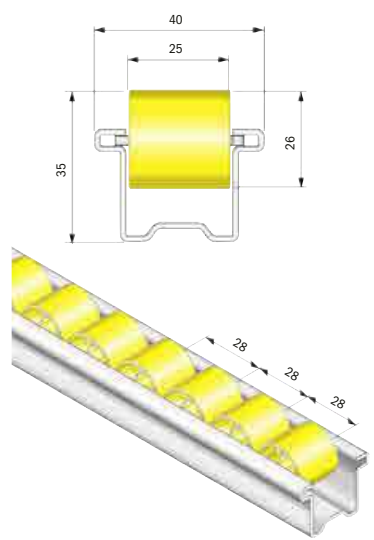

▶ **Recessed dividing rail**

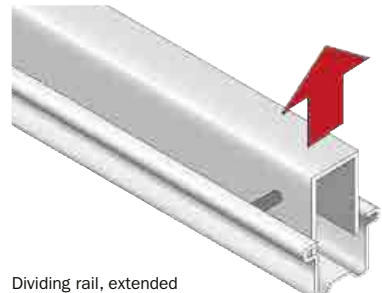

Dividing rail, extended

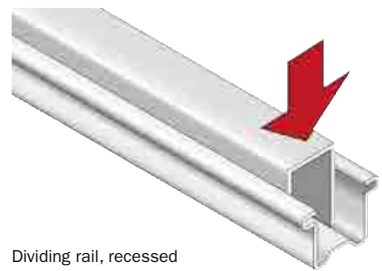

Dividing rail, recessed



- ▶ **Rigid rail profile**
with spreading reinforcement made of galvanized sheet steel
- ▶ **Sturdy and durable rollers**
made of high quality plastic, roller spacing 28 mm
- ▶ **Honeycomb-shaped roller reinforcing**
for very good form stability and smooth conveying
- ▶ **High load capacity**
5 kg per roller or 12 kg per roller for the version with a steel axle
- ▶ **Also usable in deep-freeze areas down to -30° C**
- ▶ **Long service life**

Roller tracks

The roller load capacity is 5 kg for the version with a plastic axle and 12 kg for versions with a steel axle. The roller tracks are available in lengths from 195 to 6,495 mm in 25 mm steps.

We are happy to provide you with prices above 50 m on request.

Item	Version/ rollers with	Order no.
K-R 28 K	Plastic axle	K-R28K
K-R 28 S	Steel axle	K-R28S
K-R 28 S-ESD	Steel axle	K-R28SESD

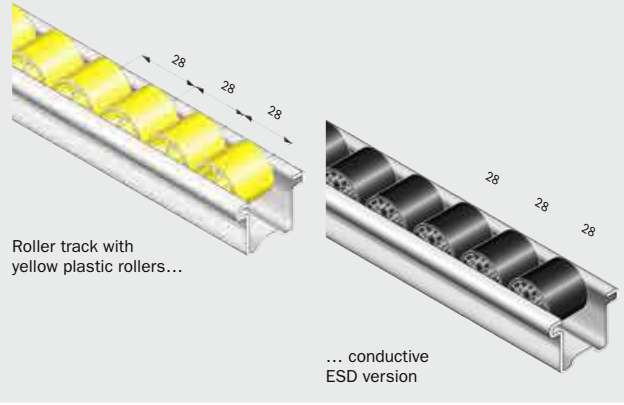

Item	Length (mm)	Order no.
K-EH-0880	780	442518
K-EH-1080	980	442538
K-EH-1280	1,180	442558
K-EH-1350	1,250	442565
K-EH-1800	1,700	442610
K-EH-2200	2,100	442650
K-EH-2700	2,600	442700

Label holder

Self-adhesive plastic label holders, total height 33 mm (for label height 30 mm). Without label inserts.

Other versions available on request.

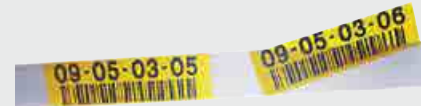

Order no. = on stock

Flow beds with roller tracks and dividing rails – configuration examples

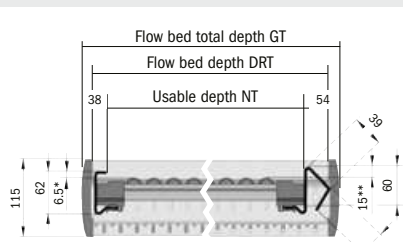

* Stop height on the supply side
** Stop height on the removal side

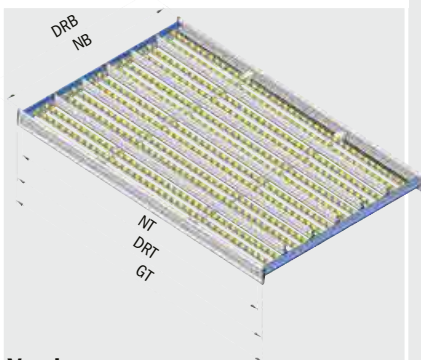

Version Flat K-D

Equipped with 12 roller and 5 recessed dividing rails, including adjustment hooks.

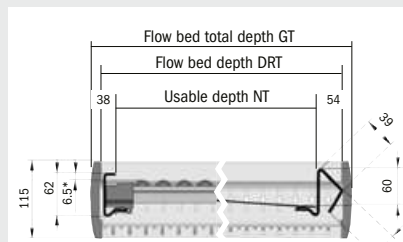

* Stop height on the supply side

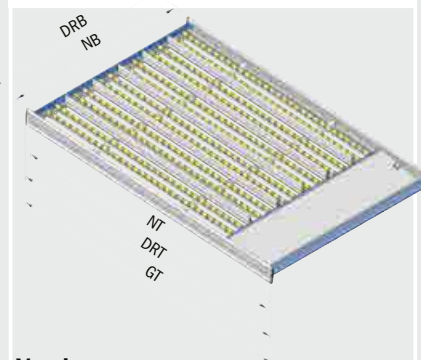

Version Flat/tilted K-DGK

Equipped with 12 roller and 5 recessed dividing rails, including adjustment hooks.

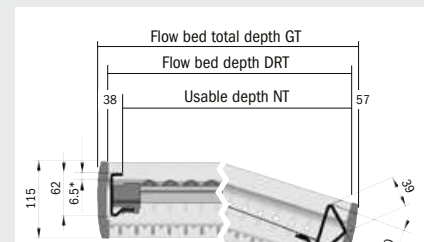

* Stop height on the supply side

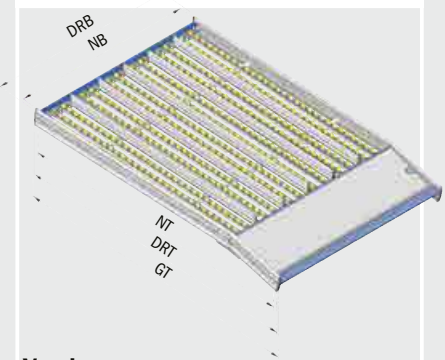

Version Tilted K-DK (10° – 16°)

Equipped with 12 roller and 5 recessed dividing rails, including adjustment hooks.

Boxes / containers

Modular shelving

Longspan racking

Pallet racking

Cantilever racking

Mezzanines / platforms

On-line shelving / KDR shelving

Semi-automated solutions

Logistics systems

Appendix

Various areas of use for KDR – application examples

The advantages of live storage shelving:

- ▶ Rapid order picking by shortening the access paths, organized, clear, more compact storage, increased automation and reduction of movement paths by 85%.
- ▶ Larger storage capacity in the same area by eliminating shelving aisles.
- ▶ No out-of-date goods thanks to the first-in-first-out principle (FIFO). The stored goods always roll automatically to the removal side on roller tracks that act as rails.
- ▶ Fewer order picking mistakes due to compact product overview.
- ▶ Clear separation of supply and removal procedures; order picking is never interrupted by supply activities.
- ▶ Short, ergonomic access paths.
- ▶ Easy connection to conveying and handling technology.
- ▶ Easy handling due to the use of rollers.





Boxes /
containers

Modular
shelving

Longspan
racking

Pallet
racking

Cantilever
racking

Mezzanines /
platforms

On-line shelving /
KDR shelving

Semi-automated
solutions

Logistics
systems

Appendix